

BSM ROTARY GEAR PUMPS

HEAVY DUTY S-SERIES



FT. MTD. PUMP

The Heavy Duty S-Series pumps are designed to handle a wide variety of liquids and are particularly suitable for bulk transfer applications where long life and dependable service is required. The pumps are easy to install and maintain and are available in different materials to meet specific requirements.

Design: Drive speeds to 1140 rpm; discharge pressures to 300 psi; flow rate to 175.0 gpm; foot mounted. Bronze or Ductile Iron thrust plates.

Material: Cast Iron casings with precision machined, heat treated gears and case hardened shafts. Pumps are also available in Ductile Iron.

Bearings: Anti-friction. Also available with iron or carbon graphite sleeve bearings.

Seal: Mechanical seal. Also available with packed seal.

Lubrication: Self lubricating using the pumped liquid. Also available for handling non-lubricating liquids.

Rotation: Clockwise or counter-clockwise rotation. A reversible back drain permits direction of rotation to be easily changed in the field.

Liquid Viscosities: 100 ssu to 100,000 ssu. Clean liquids having good lubricating qualities. Adaptable for handling liquids of higher or lower viscosities.

Suction Lift: 28 Hg / 31 feet depending on the type of liquid being pumped.

Drive Options: D-Drive (pump coupled to motor mounted on baseplate); GR-Drive (pump coupled to gear reducer coupled to motor mounted on baseplate); B-Drive (pump and motor connected by V-belt and pulleys mounted on baseplate).

Accessories: Repair Kits; Gear Sets; and Seal Kits. Refer to Section 13.

BSM ROTARY GEAR PUMPS

DIMENSIONAL DATA HEAVY DUTY S-SERIES

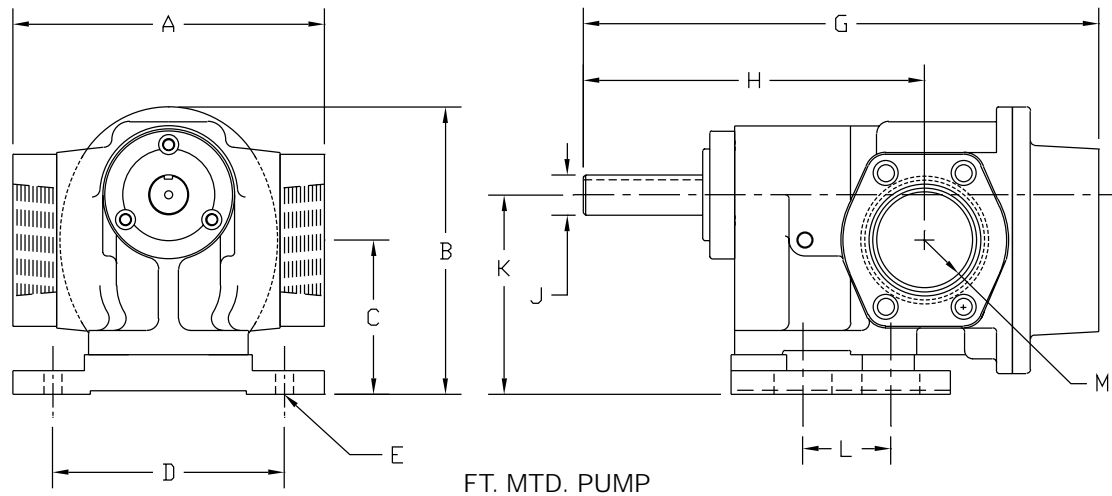

DIMENSIONS (INCHES)

Model	A	B	C	D	G	H	J	K	M	Keyway
6S	8.00	6.25	2.91	5.25	13.88	9.56	1	4.25	2"	1/4 x 1/8
8S	9.75	9.00	4.58	7.25	16.13	10.63	1 1/4	6.25	3"	"
10S	9.75	9.00	4.58	7.25	16.13	10.63	"	6.25	3"	"
12S	12.125	11.56	6.06	10.00	18.50	11.94	1 1/2	8.00	4"	3/8 x 3/16
14S	12.125	11.56	6.06	10.00	18.50	11.94	"	8.00	4"	"

OPERATING CHARACTERISTICS

Model	Displmnt gals. per rev.	Slip gpm/psi	Drive Speed rpm	0 psi		50 psi		75 psi		100 psi		200 psi		300 Psi	
				gpm	hp	gpm	hp	gpm	hp	gpm	hp	gpm	hp	gpm	hp
6S	0.0361	0.008	600	21.7	.6	21.5	1.3	21.4	1.6	21.3	1.9	20.8	3.2	20.4	4.5
			860	31.1	.8	30.8	1.8	30.6	2.3	30.5	2.7	29.8	4.6	29.2	6.5
			1140	41.2	1.1	40.8	2.4	40.6	3.0	40.4	3.6	39.5	6.1	38.7	8.6
8S	0.056	0.013	600	33.6	.9	33.3	1.9	33.2	2.5	32.9	2.9	32.3	4.9	31.6	7.0
			860	48.2	1.3	47.8	2.8	47.5	3.5	47.2	4.2	46.2	7.1	45.3	10.0
			1140	63.9	1.7	63.3	3.7	63.0	4.7	62.6	5.6	61.3	9.4	60.0	13.3
10S	0.079	0.018	600	47.7	1.3	47.2	2.7	47.0	3.5	46.7	4.2	45.8	7.1	44.8	9.9
			860	68.3	1.8	67.7	3.9	67.4	5.0	67.0	6.0	65.6	10.1	64.3	14.3
			1140	90.6	2.4	89.7	5.2	89.3	6.6	88.8	7.9	87.0	13.4	85.2	18.9
12S	0.113	0.026	600	67.8	1.8	67.1	3.8	66.8	4.9	66.4	5.9	65.1	10.1	63.7	14.1
			860	97.2	2.6	96.2	5.5	95.7	7.0	95.2	8.4	93.2	14.4	91.3	20.2
			1140	128.8	3.4	127.5	7.3	126.9	9.3	126.2	11.2	123.6	19.1	121.0	26.8
14S	0.204	0.035	600	122.2	3.2	121.0	6.9	120.3	8.8	119.7	10.6	117.3	18.1	114.8	25.5
			860	175.1	4.6	173.4	9.9	172.5	12.6	171.6	15.2	168.1	25.9	164.6	36.5

* Delivery and input horsepower are based on liquid viscosity of 300 ssu.

BSM ROTARY GEAR PUMPS

HEAVY DUTY S-SERIES

OPERATING CHARACTERISTICS, 32 SSU LIQUID

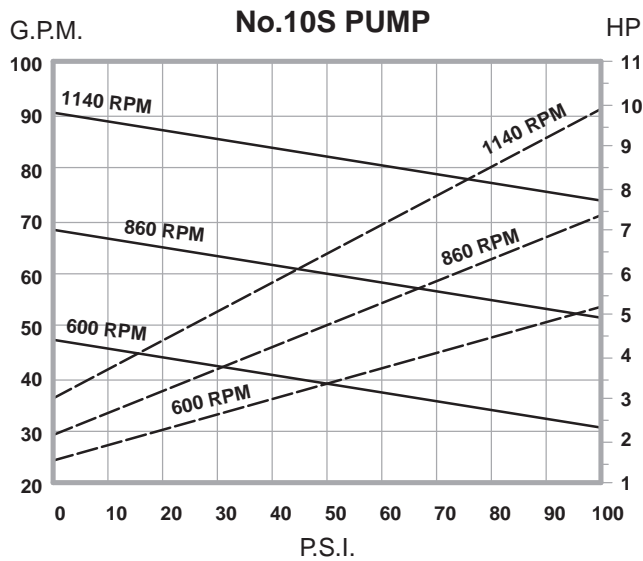
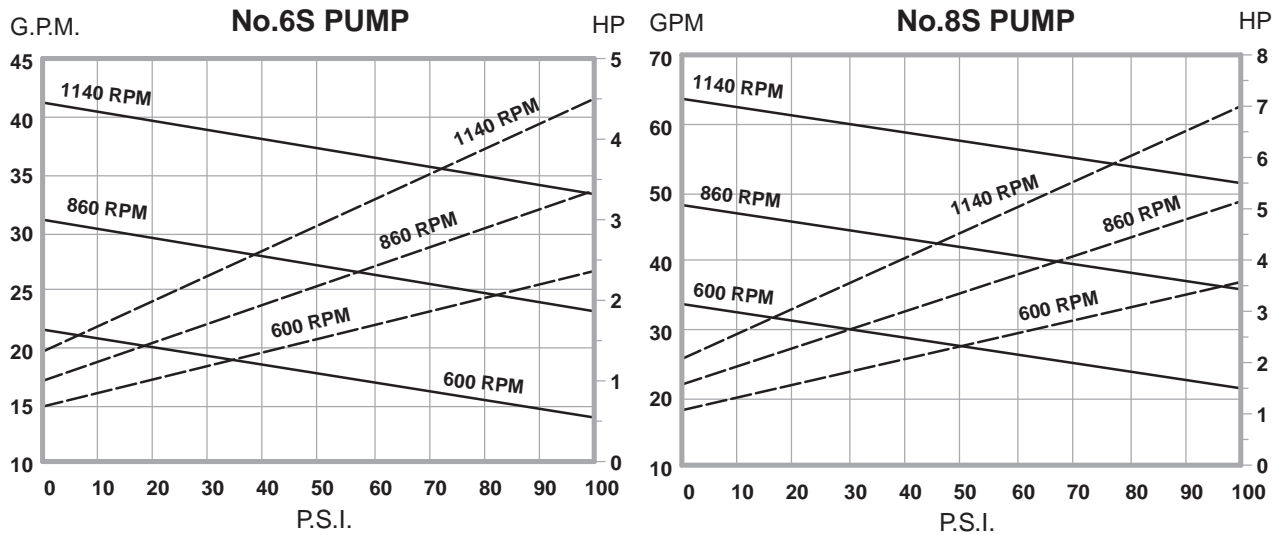

SOLID LINE = GPM
 BROKEN LINE = HP

BSM ROTARY GEAR PUMPS

HEAVY DUTY S-SERIES

OPERATING CHARACTERISTICS, 300 SSU LIQUID

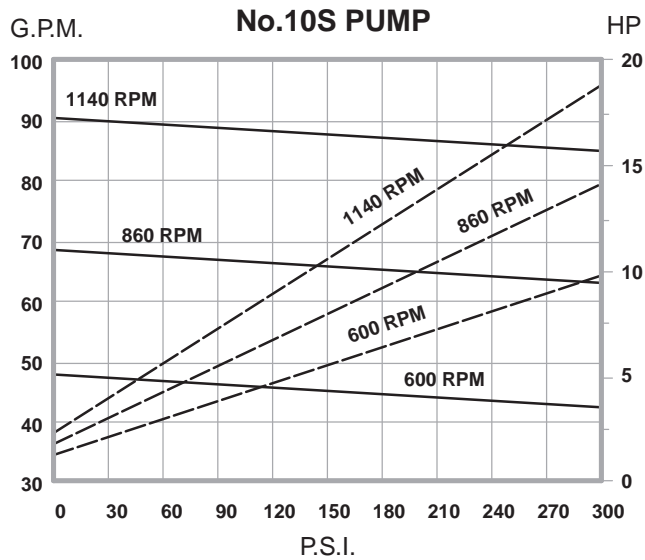
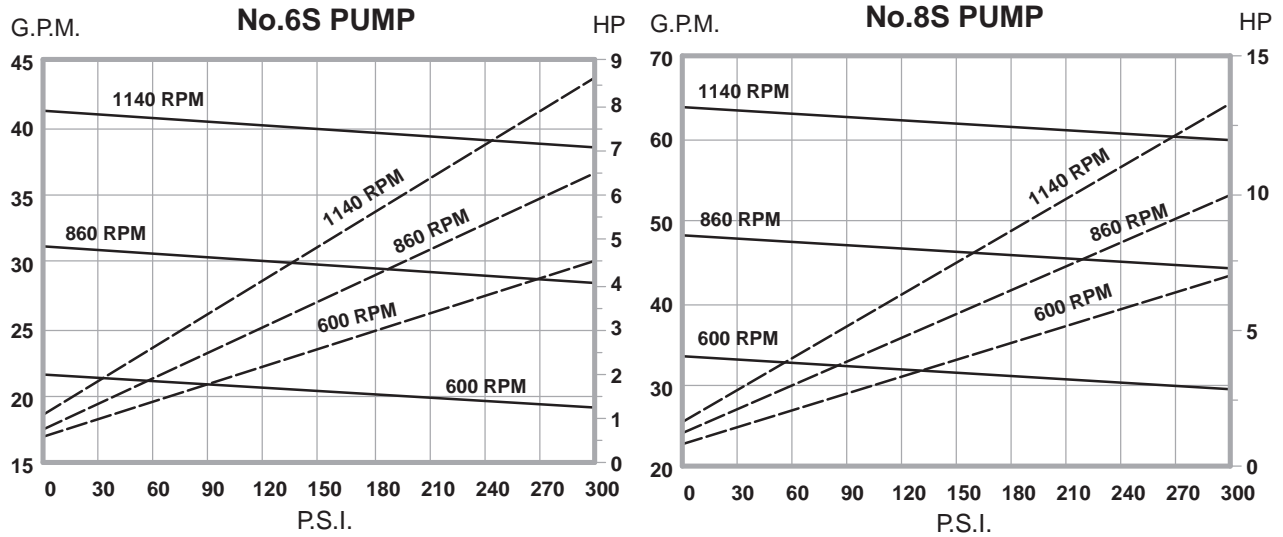

SOLID LINE = GPM
 BROKEN LINE = HP

BSM ROTARY GEAR PUMPS

HEAVY DUTY S-SERIES

OPERATING CHARACTERISTICS, 1,000 SSU LIQUID

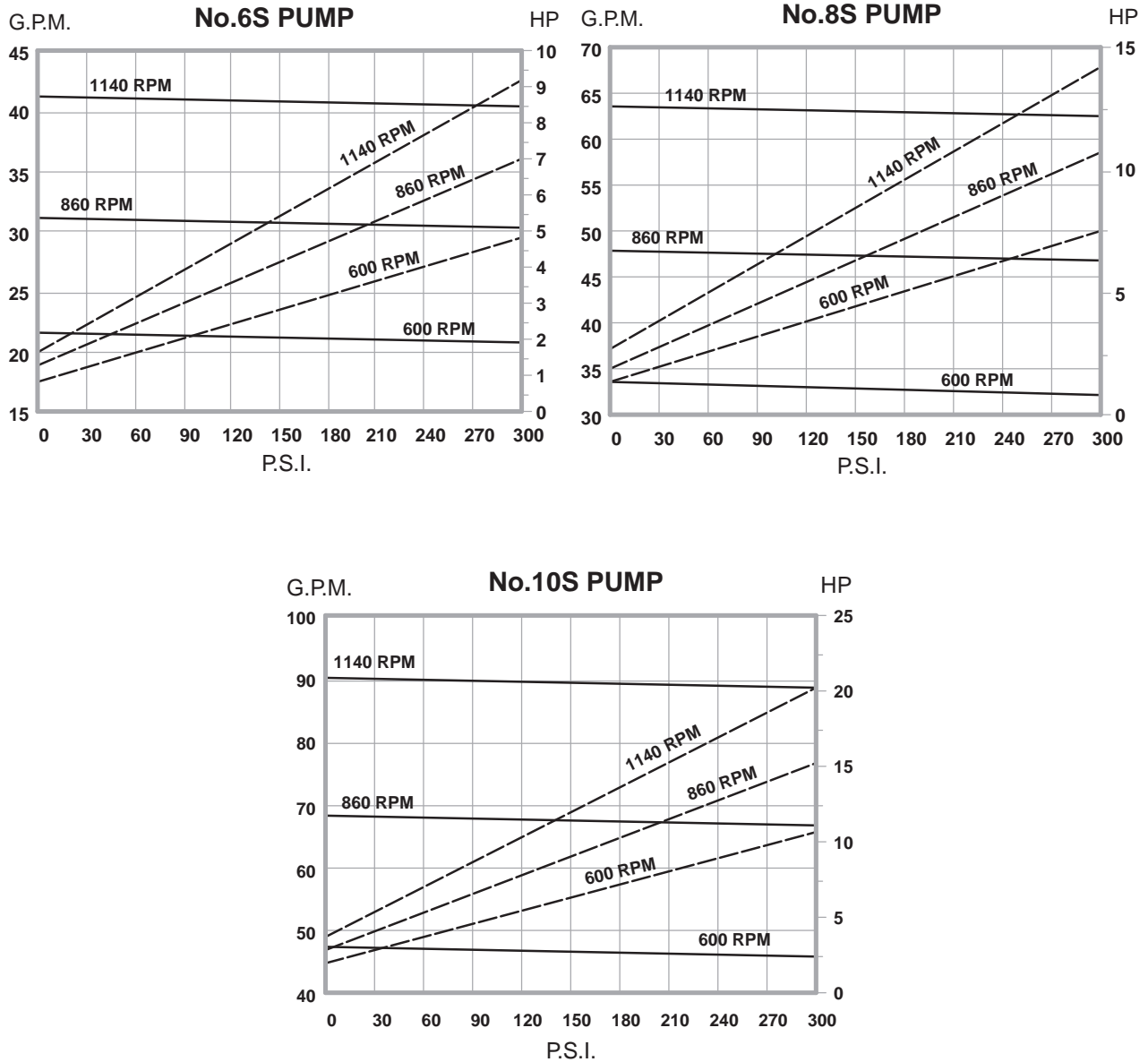

SOLID LINE = GPM
BROKEN LINE = HP

BSM ROTARY GEAR PUMPS

HEAVY DUTY S-SERIES

OPERATING CHARACTERISTICS, 5,000 SSU LIQUID

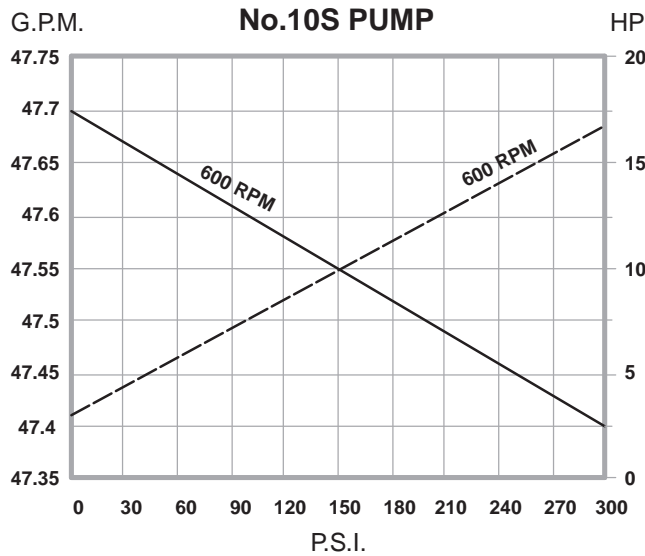
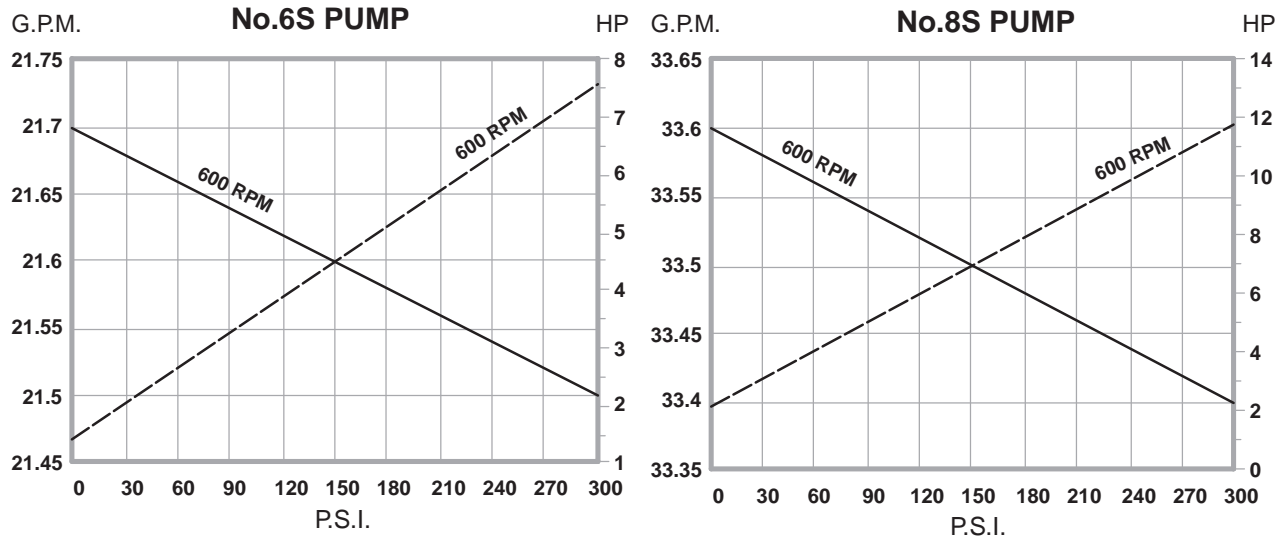

SOLID LINE = GPM
BROKEN LINE = HP

BSM ROTARY GEAR PUMPS

HEAVY DUTY S-SERIES

OPERATING CHARACTERISTICS, 32 SSU LIQUID

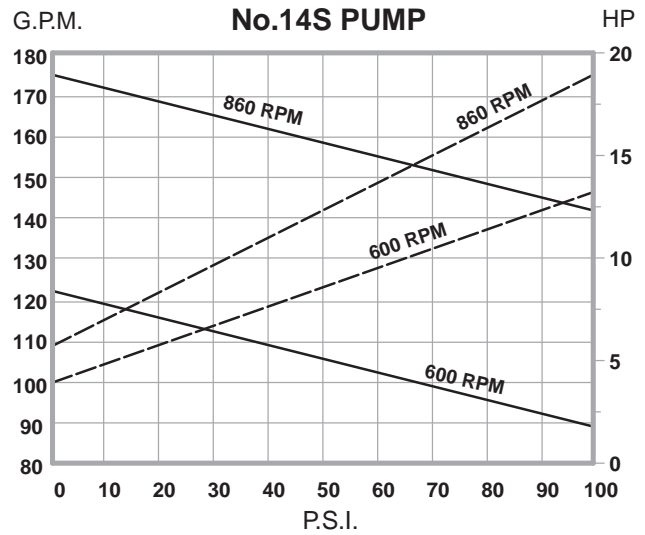
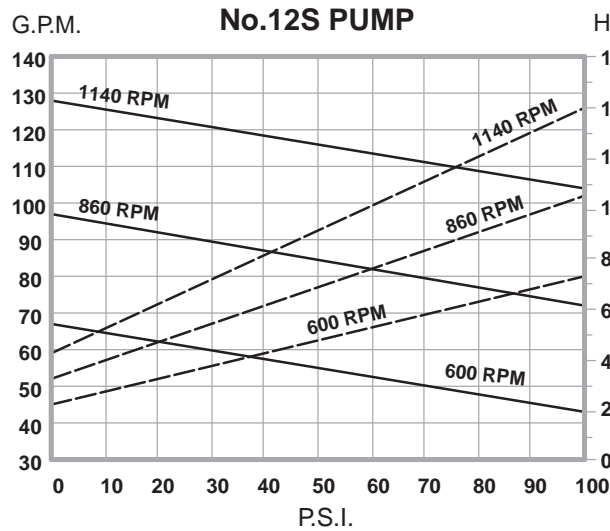

OPERATING CHARACTERISTICS, 300 SSU LIQUID

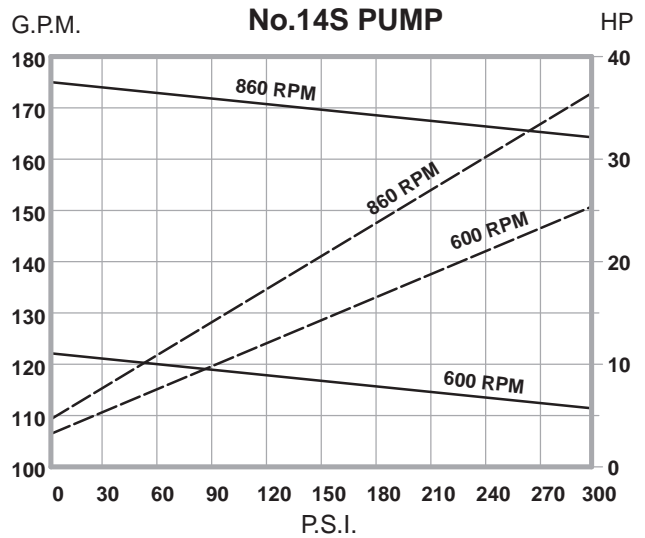
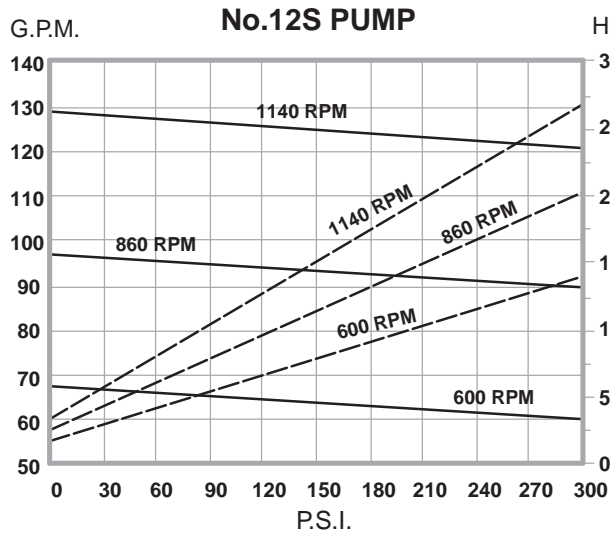

SOLID LINE = GPM
BROKEN LINE = HP

BSM ROTARY GEAR PUMPS

HEAVY DUTY S-SERIES

OPERATING CHARACTERISTICS, 1,000 SSU LIQUID

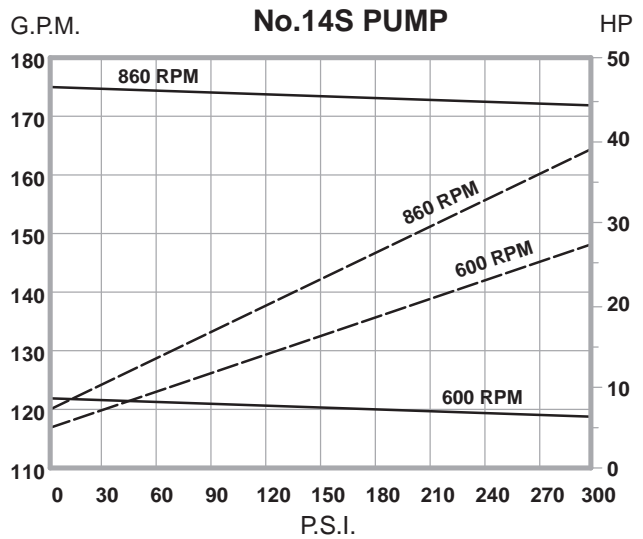
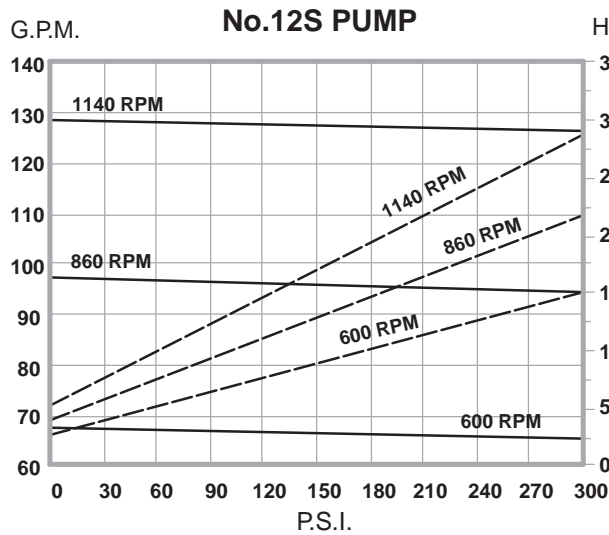

OPERATING CHARACTERISTICS, 5,000 SSU LIQUID

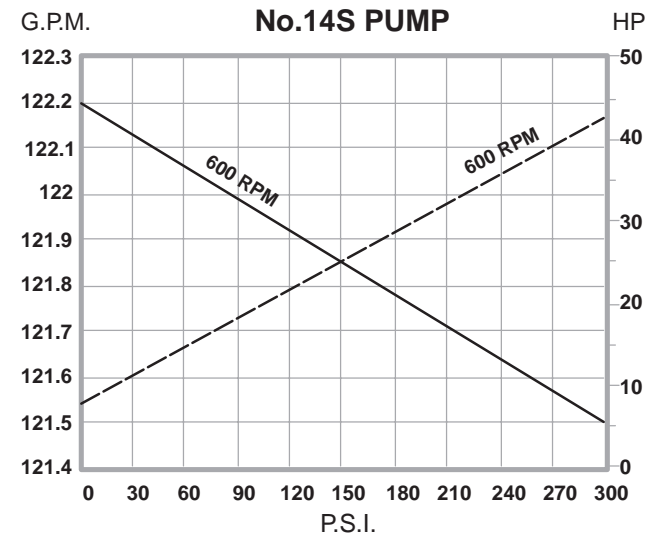
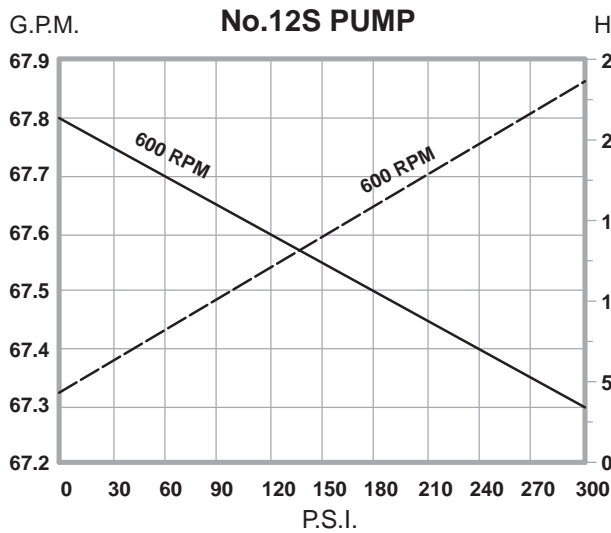

SOLID LINE = GPM
BROKEN LINE = HP

BSM ROTARY GEAR PUMPS

HEAVY DUTY S-SERIES BASE MOUNTED ASSEMBLIES (D-DRIVE)

BSM Heavy Duty S Series pumps are available as base mounted pump and motor assemblies. Each assembly includes the base, flexible coupling, coupling guard, riser blocks, (if required) lifting eyebolts, and mounting hardware. The fabricated steel or channel steel bases are available with optional features such as drip lip construction, drain plugs, mounting lugs, casters, etc..

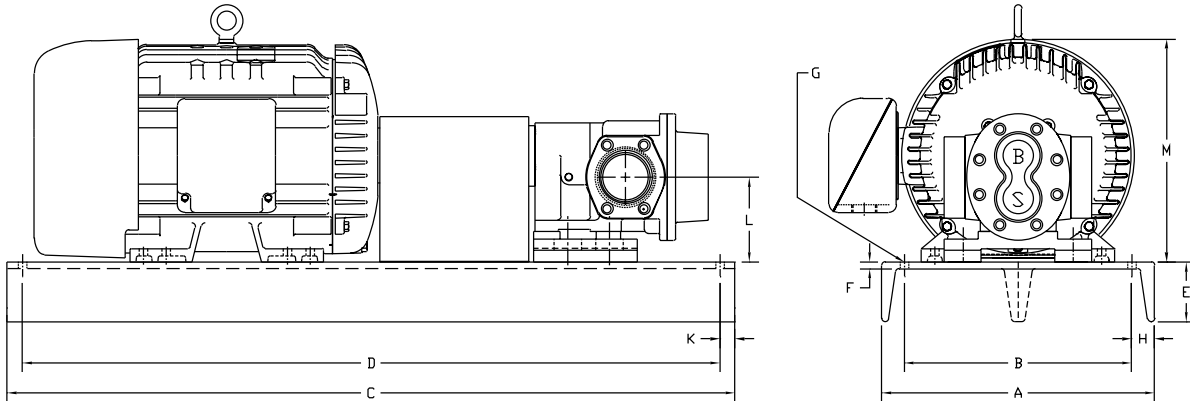

DIMENSIONS (INCHES)

Model No.	Motor Frame	A	B	C	D	E	F	G	H	K	L	M
6S-D	213T	15.00	12.00	34.00	32.00	3.41	0.41	0.56	1.50	1.00	4.16	10.25
	215T	15.00	12.00	36.00	34.00	3.41	0.41	0.56	1.50	1.00	4.16	10.25
	254T	18.00	15.00	42.00	40.00	3.95	0.45	0.56	1.50	1.00	5.16	12.88
	256T	18.00	15.00	44.00	42.00	3.95	0.45	0.56	1.50	1.00	5.16	12.88
8S-D	215T	18.00	15.00	42.00	40.00	3.95	0.45	0.56	1.50	1.00	4.83	10.25
	254T	18.00	15.00	42.00	40.00	3.95	0.45	0.56	1.50	1.00	4.83	12.88
	256T	18.00	15.00	44.00	42.00	3.95	0.45	0.56	1.50	1.00	4.83	12.88
	284T	24.00	20.00	48.00	44.00	3.17	0.51	0.63	2.00	2.00	5.58	14.63
10S-D	286T	24.00	20.00	48.00	44.00	3.17	0.51	0.63	2.00	2.00	5.58	14.63
	215T	18.00	15.00	42.00	40.00	3.95	0.45	0.56	1.50	1.00	4.83	10.25
	254T	18.00	15.00	42.00	40.00	3.95	0.45	0.56	1.50	1.00	4.83	12.88
	256T	18.00	15.00	44.00	42.00	3.95	0.45	0.56	1.50	1.00	4.83	12.88
12S-D	284T	24.00	20.00	48.00	44.00	3.17	0.51	0.63	2.00	2.00	5.58	14.63
	286T	24.00	20.00	48.00	44.00	3.17	0.51	0.63	2.00	2.00	5.58	14.63
	254T	18.00	15.00	48.00	46.00	3.95	0.45	0.56	1.50	1.00	6.06	12.88
	256T	18.00	15.00	48.00	46.00	3.95	0.45	0.56	1.50	1.00	6.06	12.88
	324T	30.00	26.00	60.00	56.00	3.72	0.72	0.63	2.00	2.00	6.06	16.50
	326T	30.00	26.00	60.00	56.00	3.72	0.72	0.75	2.00	2.00	6.06	16.50
14S-D	254T	18.00	15.00	48.00	46.00	3.95	0.45	0.75	1.50	1.00	6.06	12.88
	256T	18.00	15.00	48.00	46.00	3.95	0.45	0.56	1.50	1.00	6.06	12.88
	284T	24.00	20.00	48.00	44.00	3.17	0.51	0.56	2.00	2.00	6.06	14.63
	286T	24.00	20.00	48.00	44.00	3.17	0.51	0.63	2.00	2.00	6.06	14.63
	324T	30.00	26.00	60.00	56.00	3.72	0.72	0.63	2.00	2.00	6.06	16.50
	326T	30.00	26.00	60.00	56.00	3.72	0.72	0.75	2.00	2.00	6.06	16.50
	364T	30.00	26.00	60.00	56.00	3.72	0.72	0.75	2.00	2.00	7.06	18.50